

## SIMULATION RESULTS OF SINGLE STAGE AC- AC CONVERTER FOR INDUCTION HEATING

S.Aruguman\* and S.Rama Reddy\*\*

\* *Research Scholar Bharath University Chennai, India*  
[s\\_arumugam@rediffmail.com](mailto:s_arumugam@rediffmail.com)

\*\* *Professor Jerusalem College of Engg Chennai, India*  
[srr\\_victory@yahoo.com](mailto:srr_victory@yahoo.com)

**Abstract:** This paper presents simulation of single stage Induction heating system with series Load Resonance. Low frequency AC is converted in to High Frequency Ac using newly developed ZVS-PWM high frequency inverter. This High Frequency is used for Induction Heating .Single stage AC-AC converter system is modeled and simulated using Matlab Simulink. The simulation results of ZVS-PWM high frequency system are presented. The effectiveness of this UFAC-to-HFAC direct power frequency converter using IGBTs for consumer high-frequency IH appliances is evaluated and proved on the basis of simulation results.

**Keywords:** Induction Heating (IH), Pulse Width Modulation (PWM), Zero Voltage Source (ZVS), High frequency Inverter, Simulink.

### 1. INTRODUCTION

PRESENT and future high-speed microprocessors are becoming highly dynamic power loads to their power supplies. With the simultaneous increase in power demand and decrease in supply voltage level, new challenges arise to the power distribution and power supply design. Recently, a number of publications (R. Ordonez, H. Calleja, 1998), (N.A.Ahmed, and Y. Miura, 2005) have proposed high frequency ac (HFAC) power distribution system (PDS) as one of the alternative solution to powering the future telecommunication and computer systems. Generally, a HFAC distribution system uses a front-end inverter as "silver box" to generate high frequency ac voltage for distribution. A new application fields of high-frequency induction heating (IH) power technology in consumer and industry have developed more and more in all electricity power utilization systems as energy saving. For example, these IH appliances are IH cooking heater, IH rice cooker, IH hot water producer, IH steamer, and IH super heated steamer for cleaning, disinfecting, drying and cooking. These

new IH applications in addition to microwave oven for food processor have been expanding dramatically with tremendous development of the core technology of the state-of-the art high-frequency power electronics in IH technology. However, application-specific high frequency resonant inverters used for these appliances cause switching losses and conduction losses of power devices, getting larger cooling devices and heat release systems, decreased rated ability of power devices by switching surges. Furthermore, increased EMI/RFI noise levels due to high frequency leakage current in high frequency switching of conventional high frequency inverters operate under hard switching PWM (B.Saha, H.W.Lee, and M. Nakaoka, 2006), ( N.A. Ahmed and Y.Miura 2005). Therefore, the PFC rectifier stage is required actually. The power losses of this power stage are significant. In order to solve these practical problems, the technological developments of new high frequency resonant inverter circuit and system topologies are necessary to use high Frequency soft switching commutation as ZVS, ZCS and ZVZCS.

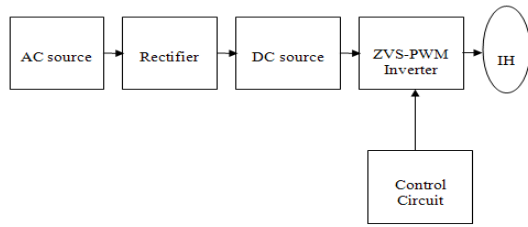

Fig.1. Block Diagram

In these two power stage series load resonant high frequency inverter with a new passive PFC rectifier, switching losses and conduction losses of the power semiconductor devices used in the circuit can be reduced and high efficiency can be achieved for the high frequency switching operation. These can have the advantages of high performance and the miniaturization, and use enough limit of rated characteristics of power semiconductor devices by reducing switching surges. Generally, the high frequency IH power appliances based on the high frequency power electronics have PFC rectifier stage, diode bridge rectifier stage as passive PFC rectifier with DCM of the inductor Current and high frequency resonant PWM inverter stage for supplying HFAC power to various HF-IH load structures resonant HF inverter have high power factor and low utility AC current harmonics characteristics in UFAC side. However, the IH direct inverter products actually need a lot of power semiconductor switching devices, passive resonant circuit components and bulky aluminum electrolytic smoothing Capacitor stack.

From these present backgrounds, this paper deals with the one stage soft switching PWM high frequency series load resonant direct inverter for IH applications. This high frequency resonant inverter topology has unique points as only one diode conducting mode passive PFC bridge rectifier operating at ZCS. In this paper, the characteristics of the high frequency direct inverter on the basis of computer simulation results are evaluated. In addition, its of the proposed series load resonant high frequency inverter is described by using the switching mode equivalent circuits in addition to the simulated operating voltage and current waveforms.

From these present backgrounds, this paper deals with the one stage soft switching PWM high frequency series load resonant direct inverter for IH applications. This high frequency resonant inverter topology has unique points as only one diode conducting mode passive PFC bridge rectifier operating at ZCS. In this paper, the characteristics of the high frequency direct inverter on the basis of computer simulation results are evaluated. In addition, its direct power regulation characteristics and UFAC side power quality characteristics in

periodic steady-state are illustrated including high frequency AC power.

## 2. SOFT-SWITCHING PWM HIGH-FREQUENCY DIRECT CONVERTER

### 2.1 Circuit description

Figure 1 shows the General Block diagram of single stage AC-AC Converter for IH Application. Figure 2.a. shows single stage ZVS-PWM high frequency power converter with passive PFC function. The proposed single stage converter has two circuit parts; passive PFC converter part (see Fig.2. b) and high frequency inverter part (see Fig.2.c). The unique feature of the proposed high frequency direct inverter in Fig. 2.a includes the direct power frequency conversion processing from UFAC to HFAC, conducting only one diode of diagonal diodes alternatively during the one switching period with passive PFC function and voltage boost function. The high frequency direct inverter without symmetric bidirectional switches consists of low pass filter with the mid point of  $C_{a1}$ ,  $C_{a2}$ ,  $L_b$  and  $L_a$ , diode bridge rectifier, boost capacitor  $C_b$ , boost inductor between neutral point of  $C_{a1}$  and  $C_{a2}$  and midpoint of switching bridge leg, power semiconductor switches  $Q_1$ ,  $Q_2$ , series resonant tuned capacitor  $C_r$  and IH load ( $R_o$ ,  $L_o$ ).

### 2.2 Principle of Operation

Figure 3 shows asymmetrical PWM processing signal trains in the case of positive half wave of UFAC side voltage source  $v_{AC}$ . The operating voltage and current waveforms in steady state are illustrated in Fig.4.a around a peak value of  $v_{AC}(t) > 0$ . The definition of the duty factor  $D$  is expressed by the following equation.

$$D = \frac{T_{on2} + t_d}{T} \quad (1)$$

Where,  $T_{on2}$  is gate duration time of the switch  $Q_2$ ,  $t_d$  is a dead time between switches;  $Q_1$ ,  $Q_2$ , and  $T$  is one cycle of HF inverter switching period.

Figure 4.b shows the circuit operating modes and switching mode equivalent circuits of the high frequency series resonant direct inverter with a new passive PFC rectifier in the case of positive half wave of UFAC voltage  $v_{AC}$ . The circuit operation in a periodic steady-state is described as follows;

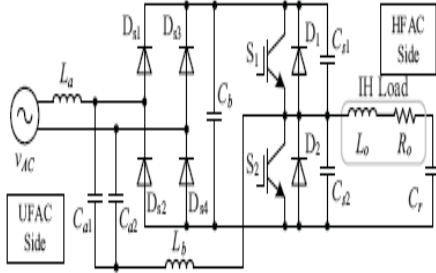

Fig. 2.a. Single stage high frequency inverter

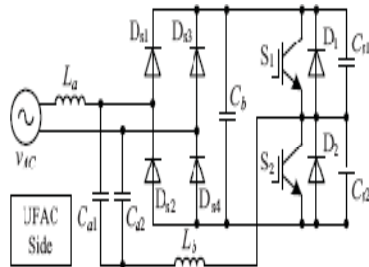

Fig.2.b. PFC converter part

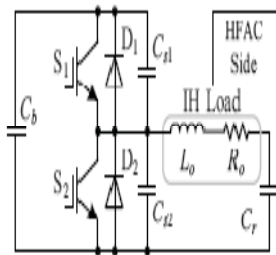

Fig.2 .c. High frequency inverter part

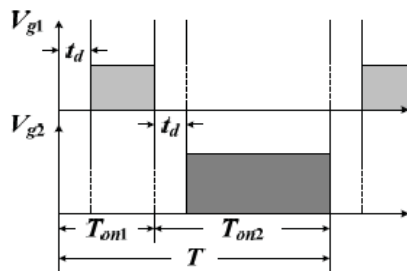

Fig. 3. Asymmetrical PWM gate pulses

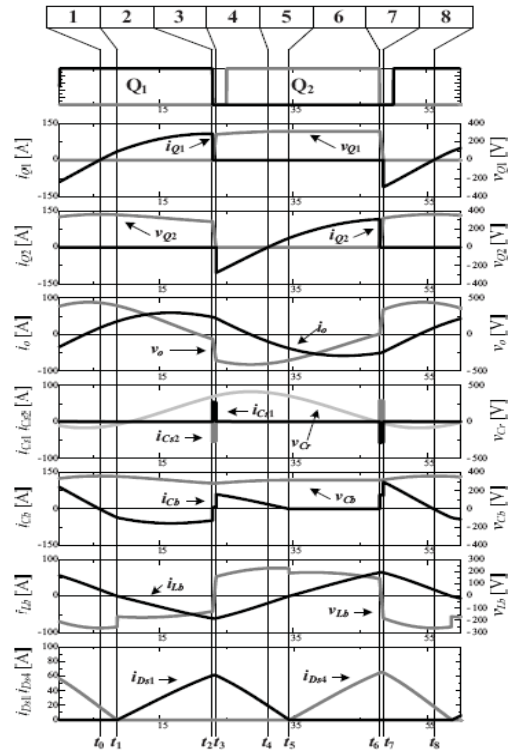

Fig. 4 .a. Operating waveforms

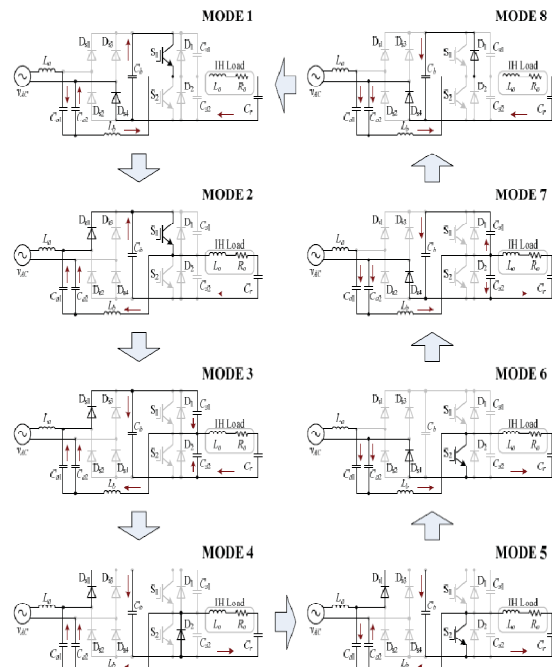

Fig.4.b. Switching mode transitions and equivalent circuits of the proposed direct high-frequency AC Converter

**Mode 1:** This circuit operating mode is started by turning-on the switch  $S_1$  of  $Q_1$ . In this mode, diode

$D_{s1}$  only in the bridge rectifier as a passive PFC also conducts. This mode ends when the switch  $S_1$  is turned off with ZVS due to the gate pulse release.

**Mode 2:** When the switch  $S_1$  is turned off with ZVS, the circuit operating mode is shifted to Mode 2. The switch  $S_1$  can achieve ZVS turn off commutation, and at this point, the diode  $D_{s1}$  only conducts continuously. In this circuit operating mode, the lossless snubbing capacitor  $C_{s1}$  in high side bridge arm is charged and  $C_{s2}$  in low side bridge arm is discharged simultaneously from a certain boosted voltage  $V_{Cb}$ . This operating mode ends when the lossless snubbing capacitors complete charging and discharging each other.

**Mode 3:** This circuit operating mode starts after charging and discharging of the lossless snubbing capacitors;  $C_{s1}$  and  $C_{s2}$ . The only one diode  $D_{s1}$  conducts and  $D_2$  of  $Q_2$  is turned on. This circuit operating mode ends when the switch  $S_2$  is turned on.

**Mode 4:** When the gate driving pulse is delivered to the switch  $S_2$  of  $Q_2$  during the operating period in Mode 3, the circuit operation in Mode 4 will start from this point. In this mode, the only one bridge diode  $D_{s1}$  conducts and switch  $S_2$  is turned on with ZVZCS as the complete soft commutation. This circuit operating mode ends when the only one bridge diode  $D_{s1}$  is turned off with ZCS for one diode conducting and boost operating mode passive PFC rectifier.

**Mode 5:** In this circuit operating mode, the switch  $S_2$  conducts and the bridge diode  $D_{s4}$  in diagonal bridge arm is naturally commutated with ZCS from  $D_{s1}$ . This operating mode ends when the switch  $S_2$  is turned off with ZVS.

**Mode 6:** This circuit operating mode starts when the switch  $S_2$  is turned off with ZVS. The only one diode  $D_{s4}$  conducts continuously. In this circuit operating mode, the lossless snubbing capacitor  $C_{s1}$  in a high side arm is discharged with the aid of series resonant IH load and, on the other hand,  $C_{s2}$  in the low side arm is charged at the same time during a dead time interval. This circuit operating mode ends when charging and discharging of the lossless snubbing capacitors  $C_{s1}$ ,  $C_{s2}$  are completely performed.

**Mode 7:** When the charging and discharging behaviors of two lossless snubbing capacitors are completed, the diode  $D_1$  of  $Q_1$  commutates from  $C_{s1}$  naturally. The low side bridge diode  $D_{s4}$  as a PFC rectifier conducts continuously. This operating mode ends when the only one conducting diode  $D_{s4}$  is turned off with ZCS and a high side bridge diode  $D_{s1}$  is turned on with ZCS.

**Mode 8:** In this circuit operating mode, the bridge diode  $D_{s1}$  is turned on with ZCS and diode  $D_1$  conducts. This circuit operating mode ends when the switch  $S_1$  of  $Q_1$  is turned on with ZVZCS.

### 3. SIMULATION RESULTS

ZVS – PWM Inverter system is simulated using simulink and their results are given here. Fig 5a. Shows the simulation circuit of AC to AC converter. Scopes are connected to measure the current and voltages. Driving pulses are shown in Fig 5b. Input current and voltage waveform are shown in Fig 5c. Output AC voltage waveforms are shown in Fig 5d. and enlarged output waveform is shown in Fig 5e. It can be seen that output voltage is almost sine wave. The low frequency AC input voltage is converted to DC using uncontrolled rectifier and its output is converter in to high frequency Ac using ZVS\_PWM Inverter.

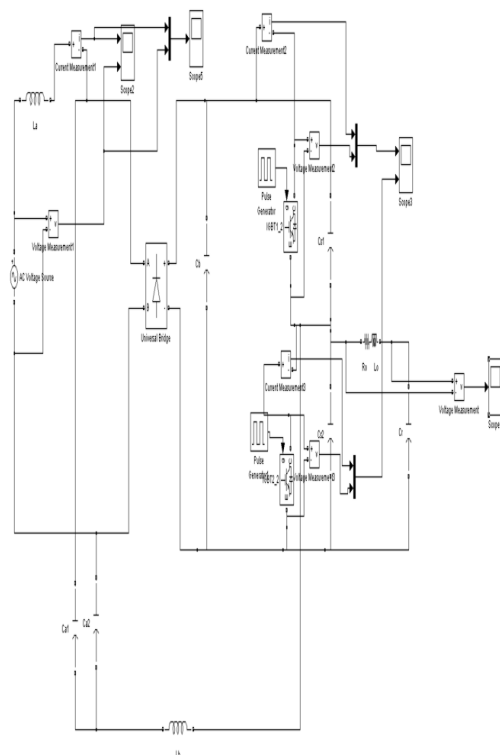

Fig. 5.a.Simulation circuit of proposed inverter

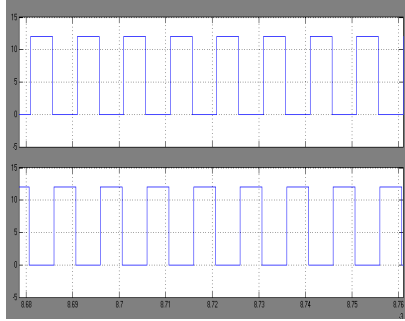

Fig. 5. b. driving pulses

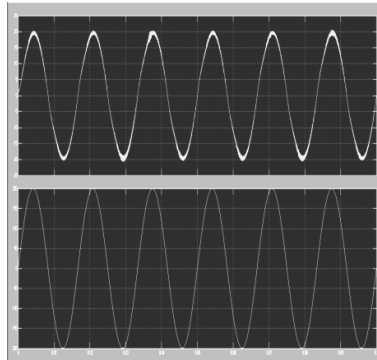

Fig. 5. c. Input current & voltage waveforms

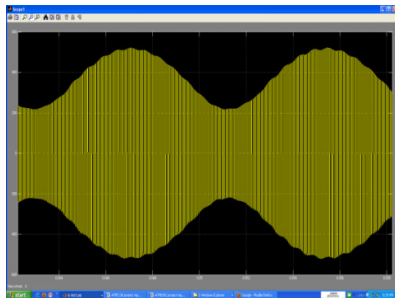

Fig. 5. d. Output voltage waveform

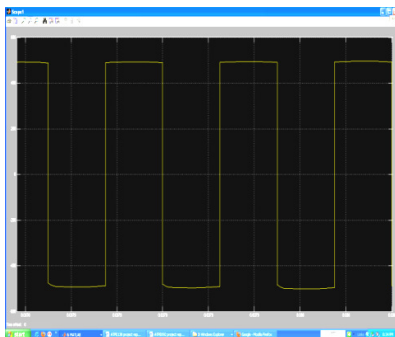

Fig. 5. e. Enlarged waveform

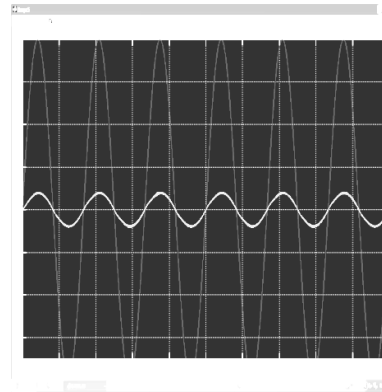

Fig.5. f. Output and input of voltage waveforms

#### 4. MAIN FEATURES

The advantageous features are summarized as follows, compared with two stage power frequency conversion processing scheme.

(a) The diodes of the diode bridge circuit are turned on and off with ZCS. The diode recovery currents and their power losses could be minimized.

(b) Only one diode switch can conduct in bridge rectifier stage for passive PFC converter equipped with utility AC side grid. The diode conduction losses in the utility side diode bridge rectifier can be reduced in principle. Ds1, Ds4 for  $v_{AC} > 0$  and Ds2, Ds3 for  $v_{AC} < 0$  can achieve ZCS.

(c) The capacitance in DC boost link can be reduced. The film capacitor could be used in replace of the DC electrolytic capacitor. The ESR of the boosted DC capacitor can be lowered. Its power loss and temperature rise might be minimized. The total power factor in UFAC side becomes unity and line harmonic current components in the UFAC side can be reduced without complex specific control procedure with sensor less scheme

(d) The high frequency AC power for IH load can be regulated by the simple asymmetrical PWM under the conditions of the soft commutation and constant frequency.

(e) Total system efficiency could be higher. The high power density might be achieved under simple cooling scheme and energy saving.

(f) The DC component of working coil in IH load can be zero due to the series resonant load with tuned series capacitor.

(g) The envelope of output high frequency current has the same sine wave as that in UFAC side.

## 5. CONCLUSIONS

This paper has proposed and discussed single stage AC-AC converter for a variety of consumer induction heating (IH) appliances such as IH cooker, IH hot water producer, IH steamer and IH super heated steamer. This high frequency series load resonant tuned direct inverter using lossless snubbing capacitors has a high efficiency passive PFC rectifier operating with one diode conduction. Its operating principle was described by using switching mode equivalent circuits for positive half cycle of UFAC voltage and negative half cycle of UFAC voltage. Its soft switching operating range was also illustrated for duty factor adjustment. The output power of the high frequency series load resonant inverter treated here could be continuously regulated by constant frequency asymmetrical PWM control from 200W to 2kW which is designed for built-in IH cooking appliances. Furthermore, the proposed direct high frequency inverter circuit topology has lowered line current harmonic contents and THD characteristics in UFAC side, and utility power factor characteristics in UFAC side. Also this system has advantages like low switching loss and reduced stress the models are developed and they are successfully used for simulation studies. The simulation results are in line with predictions.

## REFERENCES

- R.Ordonez, H.Calleja (1998) "Induction heating inverter with power factor correction", *VI IEEE International Power Electronics Congress (CIEP)*, pp.90-95.
- H.Calleja, R.Ordonez (1999) "Improved induction-heating inverter with power factor correction", *Proceedings of 30th Annual IEEE Power Electronics Specialists Conference (PESC)*, Vol.2, pp.1132-1137.
- H.Tanimatsu, and T.Ahmed (2005) "Two-switch boost-half bridge and boost active clamped ZVS-PWM AC-AC converters for consumer high frequency induction heater", *Proceedings of Twentieth Annual IEEE Applied Power Electronics Conference and Exposition (APEC)*, Vol.2, pp.1124-1130.
- N.A.Ahmed and Y.Miura (2005) "Quasi-Resonant Dual Mode Soft Switching PWM and PDM High-Frequency Inverter with IH Load Resonant Tank" *Proceedings of IEEE Power Electronics Specialists Conference (PESC)*, pp.2830-2853.

- H.Sugimura, A.M.Eid, and S.K.Kwon (2005) "High frequency cyclo-converter using one-chip reverse blocking IGBT based bidirectional power switches", *Proceedings of the Eighth International Conference on Electrical Machines and Systems (ICEMS)*, Vol.2 pp.1095-1100.
- B.Saha, H.W.Lee, and M.Nakaoka (2006) "Utility Frequency AC to High Frequency AC Power Converter with Boost-Half Bridge Single Stage Circuit Topology", *Proceedings of IEEE International Conference on Industrial Technology (ICIT)*, pp.1430-1435.
- Y.Kawaguchi, E.Hiraki, and T.Tanaka (2007) "Full bridge phase-shifted soft switching high-frequency inverter with boost PFC function for induction heating system" *Proceedings of European Conference on Power Electronics and Applications (EPE)*, pp.1-8.
- C.S.Seo, J.W.Park, and K.Y.Sim, (2005), "A study on Single-Stage High-Power-Factor Electronic Ballast for Discharge Lamps Operating in Critical Conduction Mode," *Transactions of the Korean Institute of Electrical Engineers (KIEE), Society of Electrical Machinery and Energy Conversion Systems (EMECS)*, Vol.54B-12, pp.601-608.
- S.H.Ha, C.I.Kim, and S.W.K (2008.), "The Improvement Effect of Input Current Waveform of Two New Main Switching Boost Rectifiers," *Journal of the Korean Institute of Illuminating and Electrical Installation Engineers*, Vol.22, No.3, pp.15-26.

## About Authors



**S.Arumugam** has obtained his B.E degree from Bangalore University, Bangalore in the year 1999. He obtained his M.E degree from Sathyabama University, Chennai in the year 2005. He is presently a research scholar at Bharath

University, Chennai. He is working in the area of Resonant inverter fed Induction Heating.



**S.Ramareddy** is Professor of Electrical Department, Jerusalem Engineering College, Chennai. He obtained his D.E.E from S.M.V.M Polytechnic, Tanuku, A.P. A.M.I.E in Electrical Engg from institution of Engineers (India), M.E in Power

System from Anna University. He received Ph.D degree in the area of Resonant Converters from College of Engineering, Anna University, Chennai. He has published over 20 Technical papers in National and International Conference

proceeding/Journals. He has secured A.M.I.E Institution Gold medal for obtaining higher marks. He has secured AIMO best project awards and Vijaya Ratna Award. He has worked in Tata Consulting Engineers, Bangalore and Anna University, Chennai. His research interest is in the area of resonant converter, VLSI and Solid State drives. He is a life member of Institution of Engineers (India), Indian Society for India and Society of Power Engineers. He is a fellow of Institution of Electronics and telecommunication Engineers (India). He has published books on Power Electronics and Solid State circuits.